

RMS-2402030A - SLAVE CYLINDER ASSEMBLY

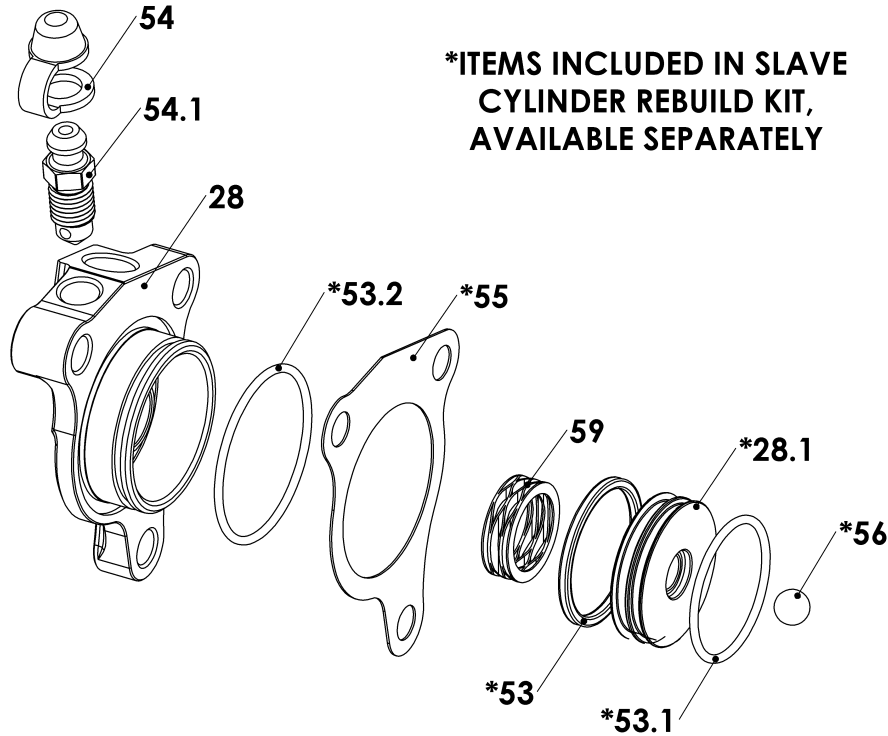

Item	Part Number	Item Description	Qty
100	747-030A	SLAVE CYLINDER ASSEMBLY - Non-Adjustable - Split Housing	1
28.1	180-313A	SLAVE CYLINDER PISTON - DIV 1.5 WS	1
28	180-420A	SLAVE CYLINDER HOUSING - Magura Split 10mm & 8mm (no	1
Not Show	184-105A	HARDWARE - Screw Sleeve, Beta - ASC to Chain Guard	1
50	414-230	HARDWARE - Crush Washers: 10mm	2
53	418-804	HARDWARE - 021 EPDM X Ring Black	1
53.2	418-915A	HARDWARE - BUNA O-ring, size 30mmID x 1.5mmW, Black	1
53.1	418-917A	HARDWARE - 1.5x24mm Viton O-ring, 75Dur	1
54	419-100A	HARDWARE - ASC Bleed Screw Cap	1
Not Show	419-104	HARDWARE - 15 in L X 1/4OD. X .17ID. Clear Vinyl Tube	1
54.1	419-125A	HARDWARE - M8x1.0 ASC, Brake Bleeder Bolt	1
55	420-301A	GASKET - Slave Cylinder - Mag,Form - fits 180-100,-112,-119	1
56	431-304	BALL BEARING - 1/4in Chrome Steel Ball	1
59	441-075A	WAVE SPRING - Slave Cylinder Return	1